

Distinctive Characteristics

Top or side actuation permits flexible board design.

Bright, LED illumination at tip of actuator.

Compact dimensions and low profile allow high density mounting and close stacking of PC boards.

Crisp actuation positively indicates circuit status.

Double molded thermoset base and thermoplastic housing prevent loosening of terminals due to high soldering temperatures.

Sliding twin contact mechanism with self-cleaning action provides smooth actuation and produces high contact reliability.

Insert molded terminals lock out flux, solvents, and other contaminants.

Inch terminal spacing for standard PC board grid (.100" x .100").

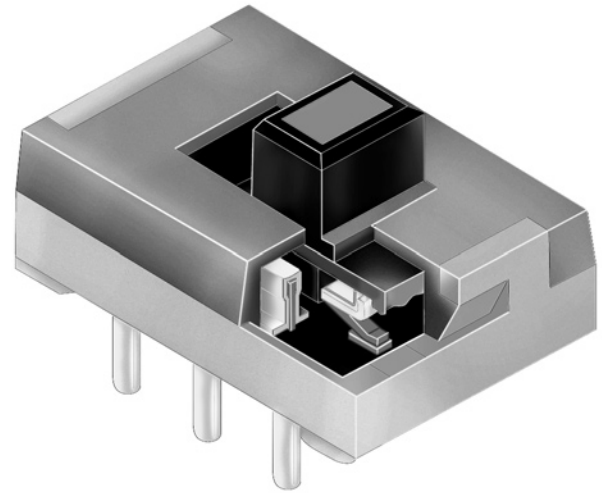

Actual Size

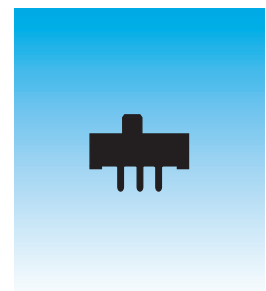

General Specifications

Electrical Capacity (Resistive Load)

Power Level: 0.1A @ 30V DC

Other Ratings

Contact Resistance: 20 milliohms maximum
Insulation Resistance: 100 megohms minimum @ 500V DC
Dielectric Strength: 500V AC minimum 1 minute minimum
Mechanical Life: 10,000 operations minimum
Electrical Life: 10,000 operations minimum
Contact Timing: Shorting (make-before-break)
Total Travel: .079" (2.0mm)

Materials & Finishes

Actuator: Polyacetal
Upper Case: Polyacetal
Lower Case: Glass fiber reinforced polyester
Movable Contactor: Phosphor bronze with silver plating
Interior Base: Phenolic resin (thermoset)
Terminals: Brass with silver plating over copper plating

Environmental Data

Operating Temp Range: -15°C through +60°C (+5°F through +140°F)
Humidity: 90 ~ 95% humidity for 96 hours @ 40°C (104°F)
Vibration: 10 ~ 55Hz with peak-to-peak amplitude of 1.5mm traversing the frequency range & returning in 1 minute; 3 right angled directions for 2 hours
Shock: 50G (490m/s²) acceleration (tested in 6 right angled directions, with 5 shocks in each direction)

PCB Processing

Soldering: Wave Soldering: See Profile B in Supplement section.
 Manual Soldering: See Profile B in Supplement section.
Cleaning: These devices are not process sealed. Hand clean locally using alcohol based solution.

Standards & Certifications

UL Recognition or CSA Certification: The SS series devices have not been tested for UL recognition and CSA certification. These switches are designed for se in a low-voltage, low-current circuit. When used as intended in a low-voltage, low-current circuit, the results do not produce hazardous energy.

TYPICAL SWITCH ORDERING EXAMPLE

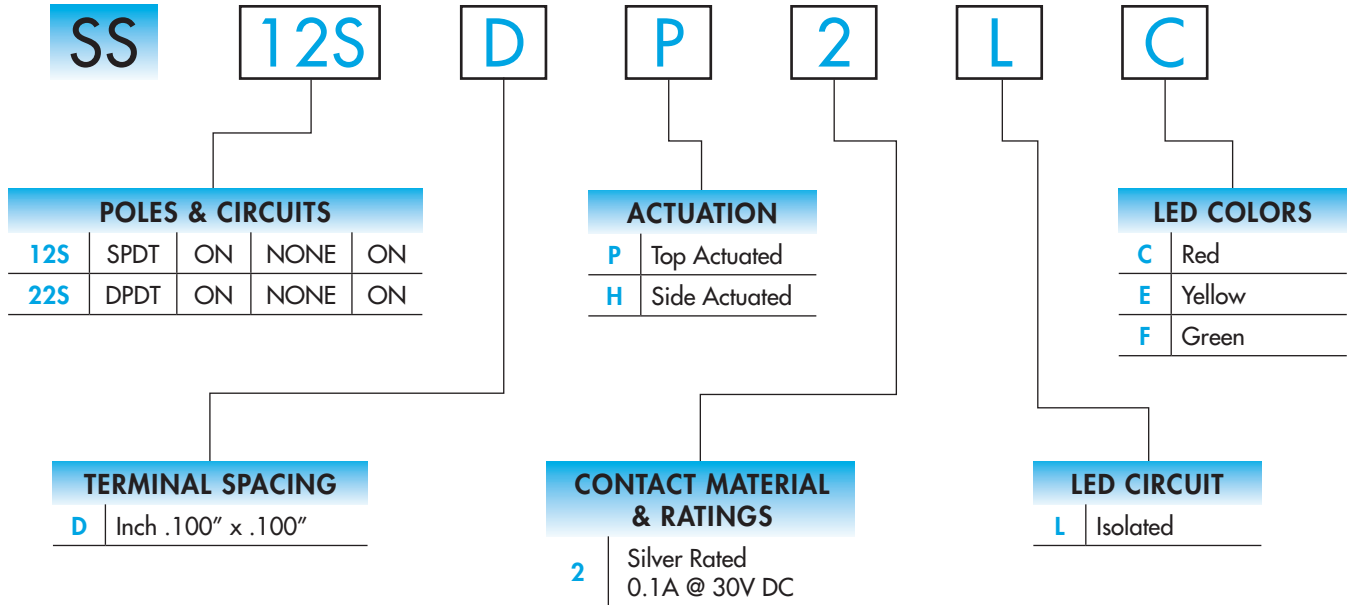

DESCRIPTION FOR TYPICAL ORDERING EXAMPLE

SS12SDP2LC

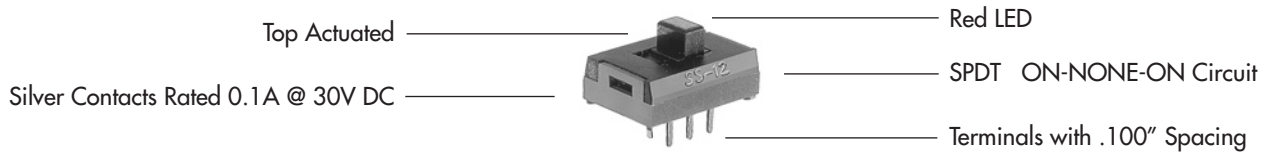

POLES & CIRCUITS

Pole	Model	Slide Position			Connected Terminals			Throw & Schematics
		Right	Center	Left	Right	Center	Left	
SP	SS12S	ON	NONE	ON	2-1	OPEN	2-3	SPDT
DP	SS22S	ON	NONE	ON	2-1 5-4	OPEN	2-3 5-6	DPDT

Note: Terminal numbers are not actually on switch. Isolated LED circuit requires external power source.

TERMINAL SPACING

D Inch .100" x .100"

Single Pole Models

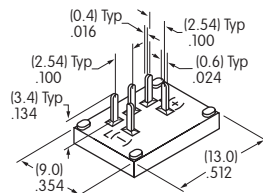

Double Pole Models

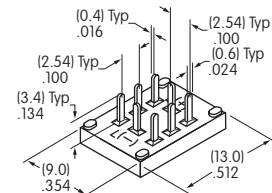

CONTACT MATERIALS & RATINGS

2

Silver over Phosphor Bronze

Power Level

0.1A @ 30V DC

TYPICAL SWITCH DIMENSIONS

Top Actuated

Single & Double Pole

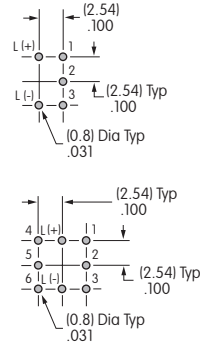
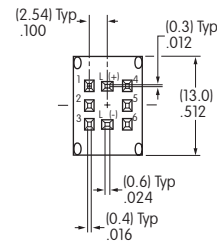
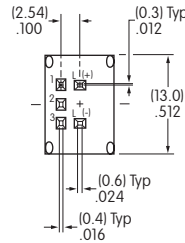
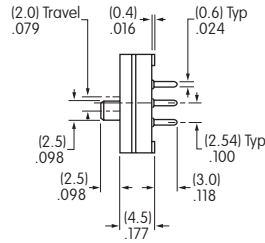
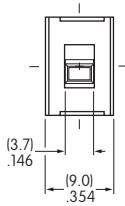

SS22SDP2LC

Side Actuated

Single & Double Pole

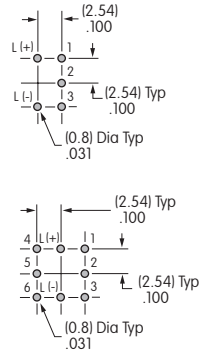
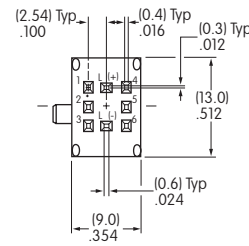
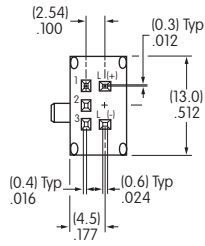
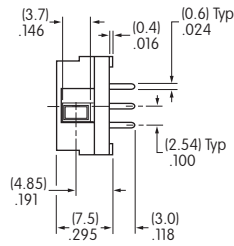
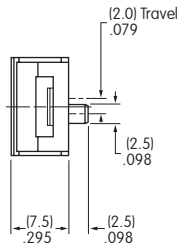

SS12SDH2LC

LED COLORS & SPECIFICATIONS

LEDs are supplied as an integral part of the switch (not available separately). The lamp circuit is independent of switch operation. Electrical specifications shown are determined at a basic temperature of 25°C. If the source voltage exceeds the rated voltage, a ballast resistor is required. The resistor value can be calculated by using the formula given in the Supplement.

L Isolated, 1-element	Color	C Red	E Yellow	F Green
		(+) - (-)		
Forward Peak Current	I_{FM}	30mA	30mA	25mA
Continuous Forward Current	I_F	16mA	16mA	16mA
Forward Voltage	V_F	1.98V	2.06V	2.16V
Reverse Peak Voltage	V_{RM}	5V	5V	5V
Current Reduction Rate Above 25°C	ΔI_F	0.40mA/°C	0.42mA/°C	0.33mA/°C
Ambient Temperature Range		-15° ~ +60°C		

OPTIONAL CAP

AT4065 Slide Cap

Material: Polycarbonate

Cap can be assembled on request

Cap Color: Black only

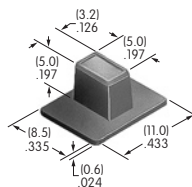

Window color should match LED color.

Colors Available:

C Red E Yellow F Green